

F-18 / C-18: 1 OPERATOR - 2 ROWS. Simple and fast adjustment of the row distance 60 to 120 cm, 7.000 plants/h per planting unit.

F-18 / C-18: 1 OPERATORE - 2 FILE. Semplicità e velocità di regolazione dell'interfila da 60 a 120 cm, 7.000 piante/ora per ogni elemento.

F-18 / C-18: 01 PERSON - 02 REIHEN. Einfache und schnelle Einstellung der Zwischenreihe von 60 bis 120cm, 7000 Pflanzen/Stunde pro Aggregat.

F-18 / C-18: 1 OPERATEUR - 2 RANGS. Réglage rapide et facile d'écartement de 60 a 120 cm, 7.000 plants/h chaque élément.

F-18 / C-18: 1 OPERADOR - 2 HILERAS. Sencillez y rapidad de ajuste de entre hilera de 60 a 120 cm, 7.000 plantas/h por cada cuerpo de siembra.

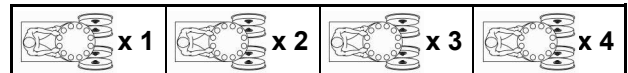

F-18 / C-18: 1 ОПЕРАТОР - 2 РЯДА. Быстрое и лёгкое регулирование междурядья от 60 до 120см, 7.000 растений в час на каждой секции.

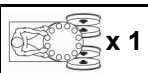
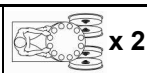
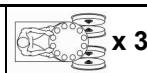
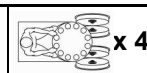

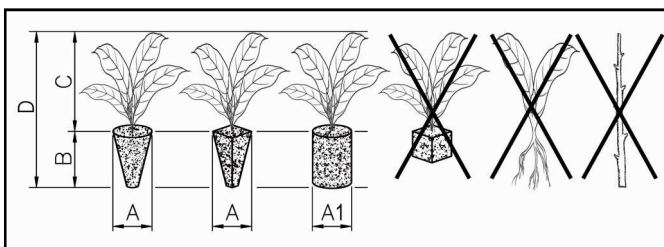
		 x 1	 x 2	 x 3	 x 4
Number of operators / Numero operatori / Bediener / Nombre de opérateurs / Numero de operadores / Количество операторов		1	2	3	4
Number of rows / Numero di file / Reihen / Nombre de rangs / Numero de surcos / количество рядов		2	4	6	8
Width / Larghezza / Breite / Largeur / Anchura / Ширина рамы	[m]	2,20	3,60-4,00	5,00-6,00	7,00-8,00
Row distance / Interfila elementi / Reihenabstand / Ecartement / Distancia entrehilera / Междурядье - "X" min. ÷ Max.	[cm]	60 ÷ 120			
Minimum row distance / Interfila elementi minima / Min. Reihenabstand / Ecartement min. / Distancia entrehilera mín. / Мин. междурядье - "Y"	[cm]	60			
Weight / Peso / Gewicht / Poids / Peso / Bec	[Kg]	750	1.050	1.400	1.700
Min HP requested / Potenza minima richiesta / Minimale HP / Min. puissance / Potencia mínima requerida / Минимальная необходимая мощность	[Hp - kW]	70 - 51	80 - 59	90 - 66	110 - 81



F-18	Min ÷ Max (cm)
A	3,0 ÷ 5,0
A1	2,5 ÷ 4,0
B	4,0 ÷ 6,0
C	8,0 ÷ 18,0
D	12,0 ÷ 25,0

C-18		
	Min ÷ Max [cm]	
A	2,0 ÷ 3,5	1,5 ÷ 2,5
A1	1,5 ÷ 2,5	/
B	4,0 ÷ 6,0	
C	8,0 ÷ 18,0	
D	12,0 ÷ 25,0	

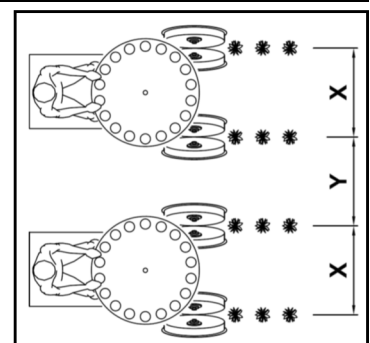

SFOGGIA
AGRICULTURE DIVISION

31044 MONTEBELLUNA - TREVISO
ITALY - Via Feltrina Sud, N°170
E-mail : info@sfggia.com
Web-site : www.sfggia.com
Tel. +39-0423-24041/2
FAX +39-0423-24014

F/C-12 / F/C-10: 1 OPERATOR - 2 ROWS. Simple and fast adjustment of the row distance 40 to 70 and 30 to 60 cm, 7.000 plants/h per planting unit.

F/C-12 / F/C-10: 1 OPERATORE - 2 FILE. Semplicità e velocità di regolazione dell'interfila da 40 a 70 cm e da 30 a 60 cm, 7.000 piante/ora per ogni elemento.



F/C-12 / F/C-10: 01 PERSON - 02 REIHEN. Einfache und schnelle Einstellung der Zwischenreihe von 40 bis 70cm und von 30 bis 60cm, 7000 Pflanzen/Stunde pro Aggregat.

F/C-12 / F/C-10: 1 OPERATEUR - 2 RANGS. Réglage rapide et facile d'écartement de 40 a 70 cm et de 30 a 60 cm, 7.000 plants/h chaque élément.

F/C-12 / F/C-10: 1 OPERADOR - 2 HILERAS. Sencillez y rapidad de ajuste de entre hilera de 40 a 70 cm y de 30 a 60 cm, 7.000 plantas/h por cada cuerpo de siembra.

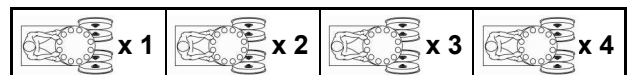

F/C-12 / F/C-10: 1 ОПЕРАТОР - 2 РЯДА. Быстрое и лёгкое регулирование междурядья от 40 до 70см - от 30 до 60см, 7.000 растений в час на каждой секции.

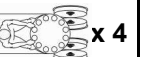

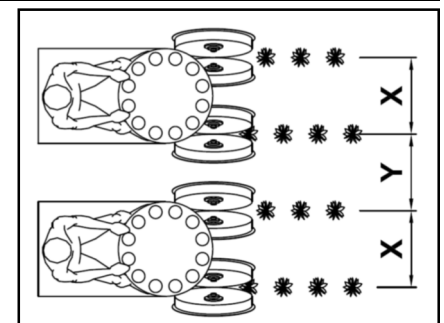
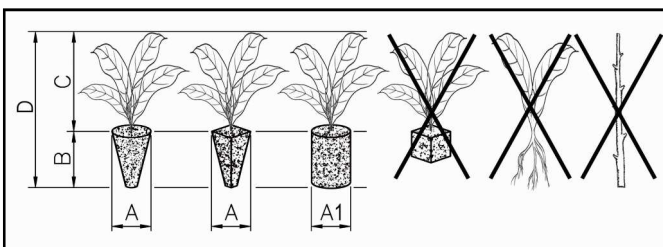
		 x 1	 x 2	 x 3	 x 4
Number of operators / Numero operatori / Bediener / Nombre de opérateurs / Numero de operadores / Количество операторов		1	2	3	4
Number of rows / Numero di file / Reihen / Nombre de rangs / Numero de surcos / количество рядов		2	4	6	8
Width / Larghezza / Breite / Largeur / Anchura / Ширина рамы	[m]	2,20	2,40	2,80	3,20
Row distance / Interfila elementi / Reihenabstand / Ecartement / Distancia entrehilera / Междурядье - "X" min. ÷ Max.	[cm]	F-12 - C-12 = 40 ÷ 70 F-10 - C-10 = 30 ÷ 60			
Minimum row distance / Interfila elementi minima / Min. Reihenabstand / Ecartement min. / Distancia entrehilera mín. / Мин. междурядье - "Y"	[cm]	F-12 - C-12 = 40 F-10 - C-10 = 30			
Weight / Peso / Gewicht / Poids / Peso / Bec	[Kg]	750	1.000	1.300	1.600
Min HP requested / Potenza minima richiesta / Minimale HP / Min. puissance / Potencia mínima requerida / Минимальная необходимая мощность	[Hp - kW]	50 - 37	60 - 44	80 - 59	100 - 74



F-12 - F-10	Min ÷ Max (cm)
A	3,0 ÷ 5,0
A1	2,5 ÷ 4,0
B	4,0 ÷ 6,0
C	8,0 ÷ 18,0
D	12,0 ÷ 25,0

C-12 C-10	 Standard		 Micro	
	Min ÷ Max [cm]			
A	2,0 ÷ 3,5	1,5 ÷ 2,5		
A1	1,5 ÷ 2,5	/		
B	4,0 ÷ 6,0			
C	8,0 ÷ 18,0			
D	12,0 ÷ 25,0			

SFOGGIA
AGRICULTURE DIVISION

31044 MONTEBELLUNA - TREVISO
ITALY - Via Feltrina Sud, N°170
E-mail : info@sfgoggia.com
Web-site : www.sfgoggia.com
Tel. +39-0423-24041/2
FAX +39-0423-24014